

出荷明細書

		現場名 四日市別山ニュータウン1号公園フォーリー1工事							
NO	名称	樹種	B 幅	H 成	L 長さ	本数	m ² /本	m ³ 数	備考
1	梁	米ひば・湾曲	90	150	2,700	8	0.0365	0.292	内R=5000
2		"	90	150	2,700	6	0.0365	0.219	"
3							0	0	
4	柱-C1	米ひば・通直	180	180	7,300	2	0.2365	0.473	
5			180	180	7,100	2	0.23	0.46	
6		"	180	180	4,600	2	0.149	0.298	
7		"	180	180	4,000	2	0.1296	0.2592	
8		"	180	180	3,000	2	0.0972	0.1944	
9		"	180	180	2,000	2	0.0648	0.1296	
10	階段柱	"	120	120	3,900	1	0.0562	0.0562	
11		"	120	120	3,100	1	0.0446	0.0446	
12		"	120	120	2,600	4	0.0374	0.1496	
13		"	120	120	2,000	6	0.0288	0.1728	
14		"	120	120	1,200	2	0.0173	0.0346	
15	床梁	"	120	300	2,900	8	0.1044	0.8352	
16		"	120	300	2,000	6	0.072	0.432	
17		"	120	300	900	8	0.0324	0.2592	
18		"	120	240	2,900	2	0.0835	0.167	
19		"	120	240	2,000	2	0.0576	0.1152	
20		"	120	240	900	2	0.0259	0.0518	
21	屋根梁	"	120	240	2,900	4	0.0835	0.334	
22	手すり	"	120	100	2,900	3	0.0348	0.1044	
23		"	120	100	2,000	9	0.024	0.216	
24		"	120	100	900	5	0.0108	0.054	
25		"	120	100	500	2	0.006	0.012	
26	手すり小柱	"	100	120	1,500	2	0.018	0.036	
27		"	100	120	1,100	3	0.0132	0.0396	
28	垂木	"	60	90	3,600	30	0.0194	0.582	
29		"	60	90	400	8	0.0022	0.0176	
30		"	60	90	700	8	0.0038	0.0304	
31		"	60	90	900	8	0.0049	0.0392	
32		"	60	90	1,200	8	0.0065	0.052	
33		"	60	90	1,400	8	0.0076	0.0608	
34		"	60	90	1,700	8	0.0092	0.0736	
35		"	60	90	1,900	8	0.0103	0.0824	
36		"	60	90	2,100	8	0.0113	0.0904	
37	方杖	"	90	90	2,300	6	0.0186	0.1116	
38		"	90	90	1,700	18	0.0138	0.2484	
39		"	90	90	1,000	10	0.0081	0.081	
40		"	90	90	700	6	0.0057	0.0342	
41	筋交い	"	60	90	1,800	6	0.0097	0.0582	
42		"	60	90	1,500	10	0.0081	0.081	
43	踏板	"	40	260	1,000	16	0.0104	0.1664	
44	ササ柵	"	100	300	1,200	8	0.036	0.288	
45									
46	床根太	米杉 210	38	230	4,000	10	0.035	0.35	
47		"	38	230	3,000	10	0.0262	0.262	
48	床板	米杉 206	38	140	3,000	90	0.016	1.44	
49									
50									
	合計					380		9.5886	

屋根梁 (米ヒバ・湾曲集成材)

内径 5,000

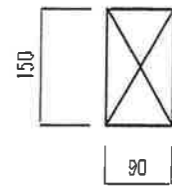

屋根梁 (米ヒバ・通直集成材)

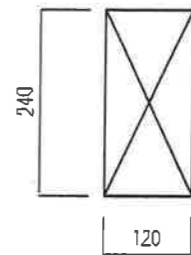

床梁 (米ヒバ・通直集成材)

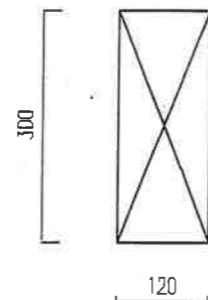

床梁 (米ヒバ・通直集成材)

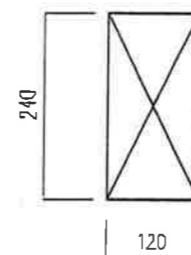

柱-C1 (米ヒバ・通直集成材)

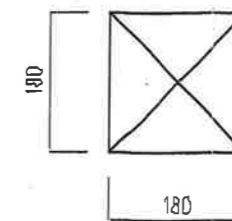

階段柱 (米ヒバ・通直集成材)

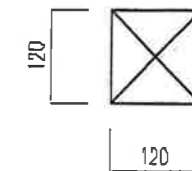

手すり (米ヒバ・通直集成材)

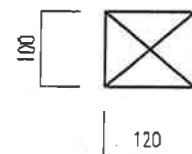

手すり小柱 (米ヒバ・通直集成材)

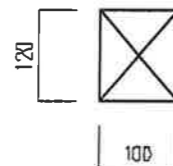

垂木 (米ヒバ・通直集成材)

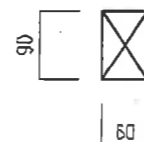

方杖 (米ヒバ・通直集成材)

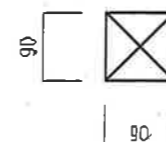

筋交い (米ヒバ・通直集成材)

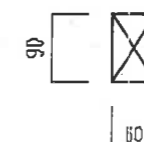

踏板 (米ヒバ・通直集成材)

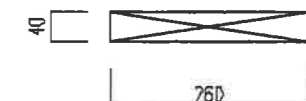

ササフ桁 (米ヒバ・通直集成材)

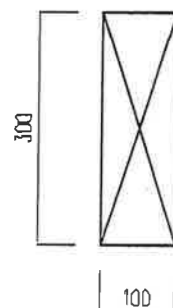

床根太 (米杉・210)



床板 (米杉・206)

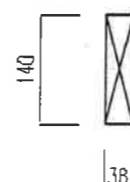

名称 四日市別山ニュータウン1号公園ファミリー1工事

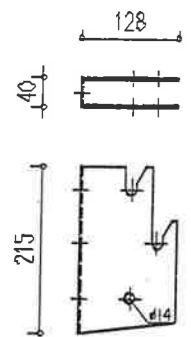

帯板金物

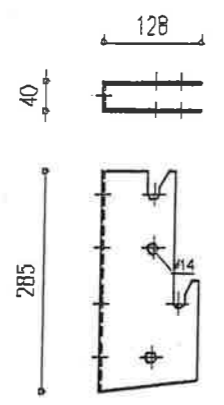

帯板金物

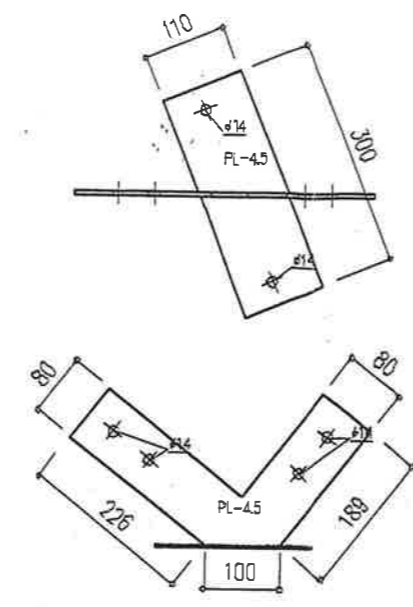

方杖T形金物

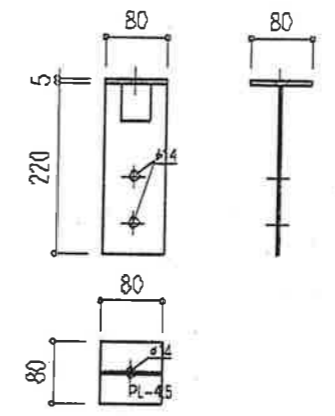

方杖T形金物

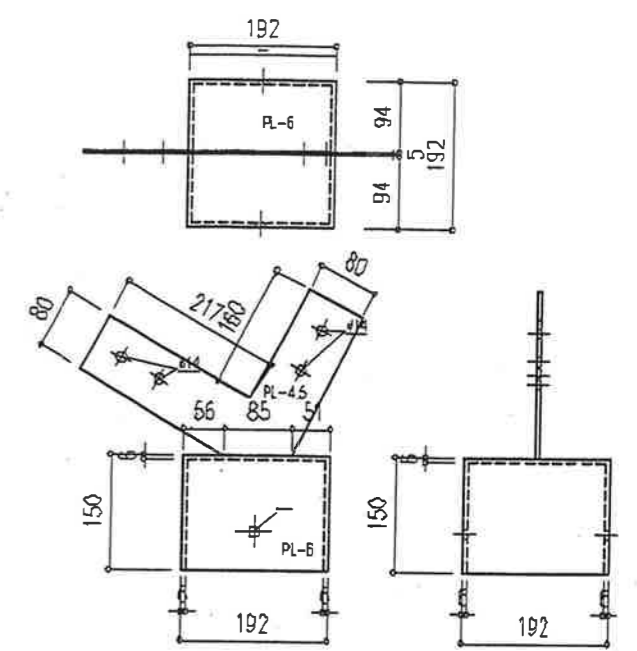

柱頭キャップ (方杖付き)

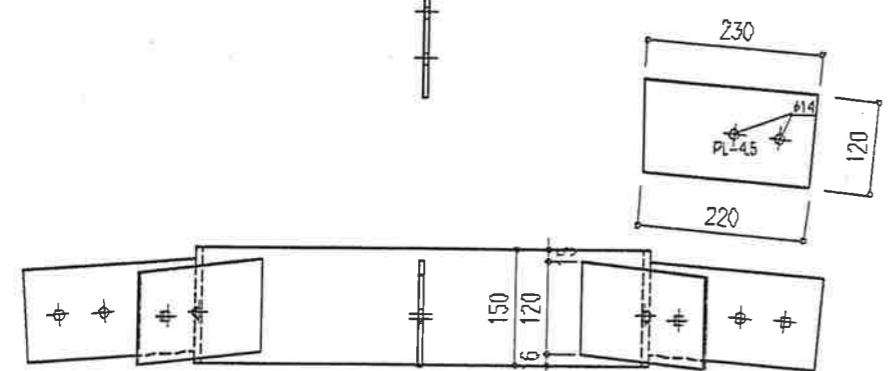
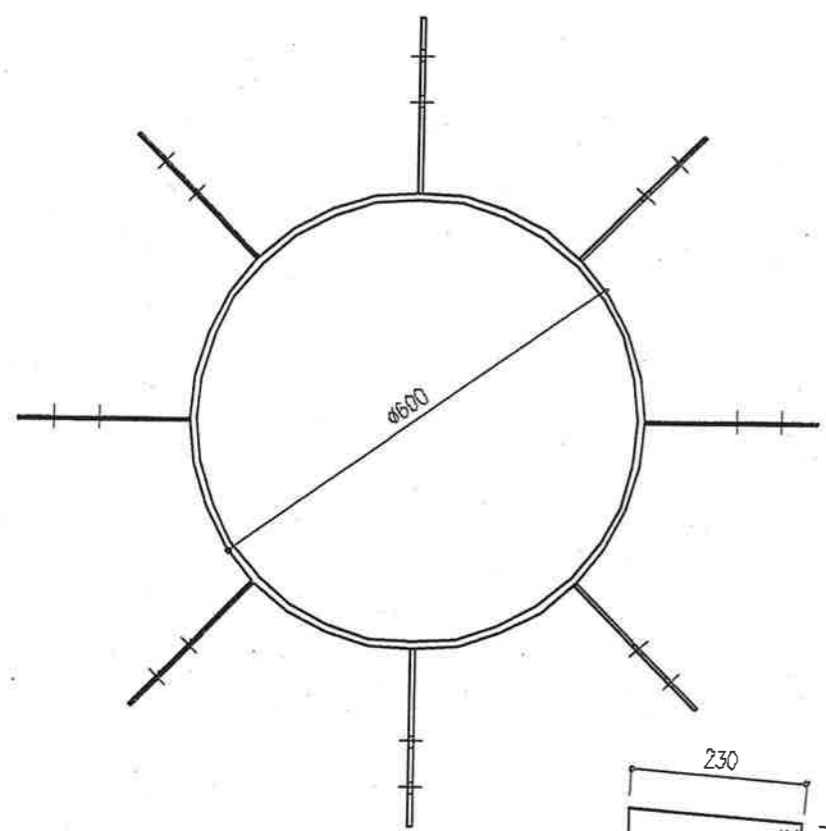

圓板センター金物

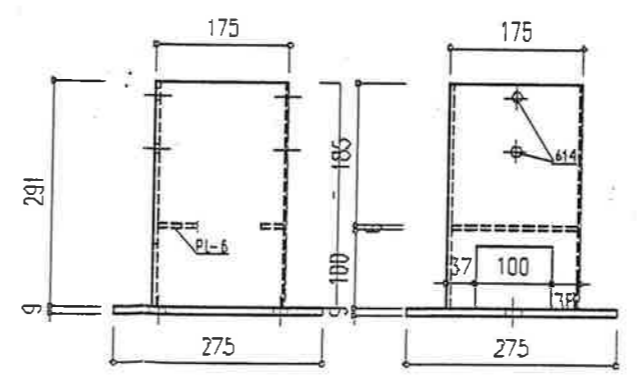
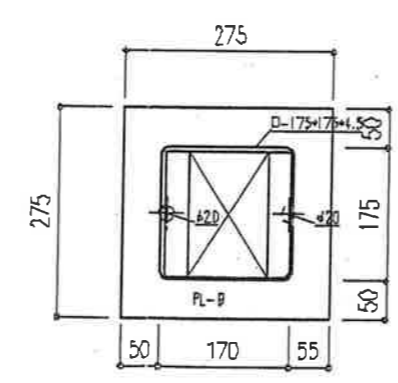

ベース金物

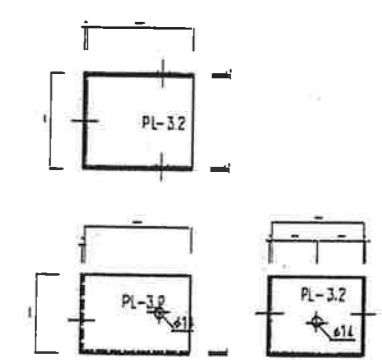

手すり受金物

鋼材 SS400
防錆処理方法 溶融亜鉛メッキ仕上

名称	四日市別山ニ-タウン1号公園フォー-1工事
----	-----------------------