

出荷明細書

|    |       | 現場名 四日市別山ニュータウン2号公園フォーリー3工事 |     |     |       |     |                   |                  |    |
|----|-------|-----------------------------|-----|-----|-------|-----|-------------------|------------------|----|
| NO | 名称    | 樹種                          | B 幅 | H 成 | L 長さ  | 本数  | m <sup>2</sup> /本 | m <sup>2</sup> 数 | 備考 |
| 1  | 屋根トラス | 米ヒバ・通直                      | 100 | 100 | 1,400 | 27  | 0.014             | 0.378            |    |
| 2  |       | 〃                           | 100 | 100 | 1,500 | 24  | 0.015             | 0.36             |    |
| 3  | 柱     | 〃                           | 120 | 180 | 4,100 | 2   | 0.0886            | 0.1772           |    |
| 4  |       | 〃                           | 120 | 180 | 3,100 | 2   | 0.067             | 0.134            |    |
| 5  |       | 〃                           | 120 | 180 | 2,300 | 2   | 0.0497            | 0.0994           |    |
| 6  |       | 〃                           | 120 | 120 | 1,400 | 2   | 0.0202            | 0.0404           |    |
| 7  | 束     | 〃                           | 120 | 120 | 800   | 1   | 0.0115            | 0.0115           |    |
| 8  | ブレース  | 〃                           | 100 | 100 | 1,600 | 4   | 0.016             | 0.064            |    |
| 9  |       | 〃                           | 60  | 100 | 1,600 | 6   | 0.0096            | 0.0576           |    |
| 10 | 手摺    | 〃                           | 120 | 100 | 2,500 | 4   | 0.03              | 0.12             |    |
| 11 | 手摺小柱  | 〃                           | 100 | 120 | 1,200 | 4   | 0.0144            | 0.0576           |    |
| 12 | 床梁    | 〃                           | 120 | 300 | 2,400 | 10  | 0.0864            | 0.864            |    |
| 13 |       | 〃                           | 120 | 300 | 4,700 | 1   | 0.1692            | 0.1692           |    |
| 14 |       | 〃                           | 105 | 260 | 2,000 | 2   | 0.0546            | 0.1092           |    |
| 15 |       |                             |     |     |       |     |                   |                  |    |
| 16 | 床根太   | 米杉 210                      | 38  | 230 | 4,000 | 5   | 0.035             | 0.175            |    |
| 17 |       |                             | 38  | 230 | 3,000 | 10  | 0.0262            | 0.262            |    |
| 18 | 床板    | 米杉 206                      | 38  | 140 | 3,000 | 70  | 0.016             | 1.12             |    |
| 19 |       |                             |     |     |       |     |                   |                  |    |
| 20 |       |                             |     |     |       |     |                   |                  |    |
| 21 |       |                             |     |     |       |     |                   |                  |    |
| 22 |       |                             |     |     |       |     |                   |                  |    |
| 23 |       |                             |     |     |       |     |                   |                  |    |
| 24 |       |                             |     |     |       |     |                   |                  |    |
| 25 |       |                             |     |     |       |     |                   |                  |    |
| 26 |       |                             |     |     |       |     |                   |                  |    |
| 27 |       |                             |     |     |       |     |                   |                  |    |
| 28 |       |                             |     |     |       |     |                   |                  |    |
| 29 |       |                             |     |     |       |     |                   |                  |    |
| 30 |       |                             |     |     |       |     |                   |                  |    |
| 31 |       |                             |     |     |       |     |                   |                  |    |
| 32 |       |                             |     |     |       |     |                   |                  |    |
| 33 |       |                             |     |     |       |     |                   |                  |    |
| 34 |       |                             |     |     |       |     |                   |                  |    |
| 35 |       |                             |     |     |       |     |                   |                  |    |
| 36 |       |                             |     |     |       |     |                   |                  |    |
| 37 |       |                             |     |     |       |     |                   |                  |    |
| 38 |       |                             |     |     |       |     |                   |                  |    |
| 39 |       |                             |     |     |       |     |                   |                  |    |
| 40 |       |                             |     |     |       |     |                   |                  |    |
| 41 |       |                             |     |     |       |     |                   |                  |    |
| 42 |       |                             |     |     |       |     |                   |                  |    |
| 43 |       |                             |     |     |       |     |                   |                  |    |
| 44 |       |                             |     |     |       |     |                   |                  |    |
| 45 |       |                             |     |     |       |     |                   |                  |    |
| 46 |       |                             |     |     |       |     |                   |                  |    |
| 47 |       |                             |     |     |       |     |                   |                  |    |
| 48 |       |                             |     |     |       |     |                   |                  |    |
| 49 |       |                             |     |     |       |     |                   |                  |    |
| 50 | 合計    |                             |     |     |       | 176 |                   | 4.1991           |    |

屋根トラス (米ヒバ・通直集成材)

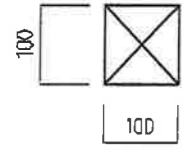

床梁 (米ヒバ・通直集成材)

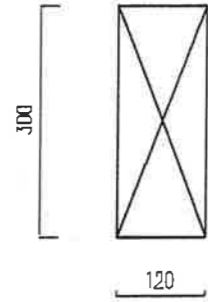

床梁 (米ヒバ・通直集成材)

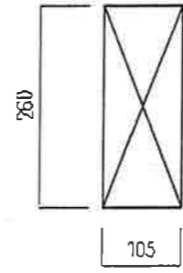

柱 (米ヒバ・通直集成材)

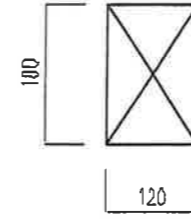

束 (米ヒバ・通直集成材)

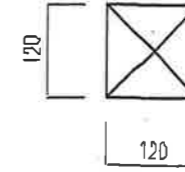

手すり (米ヒバ・通直集成材)

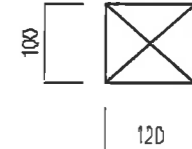

手すり小柱 (米ヒバ・通直集成材)

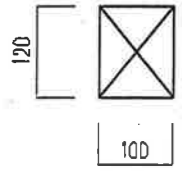

アリス (米ヒバ・通直集成材)

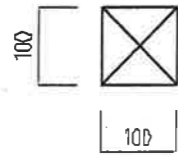

アリス (米ヒバ・通直集成材)

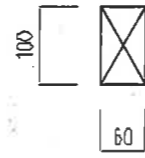

床根太 (米杉・210)

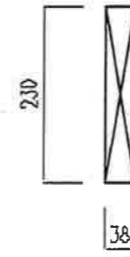

床板 (米杉・206)

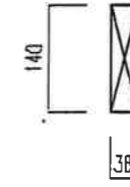

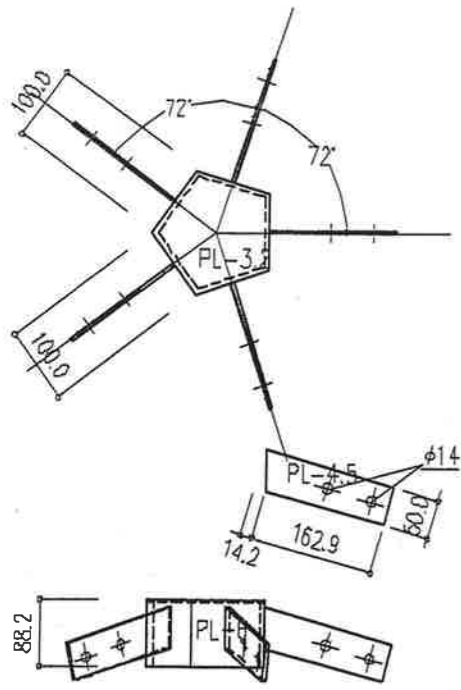

五角金物

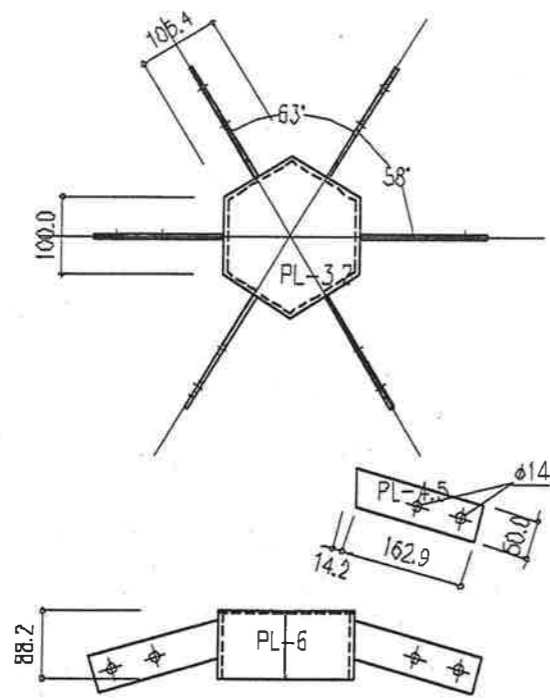

六角金物

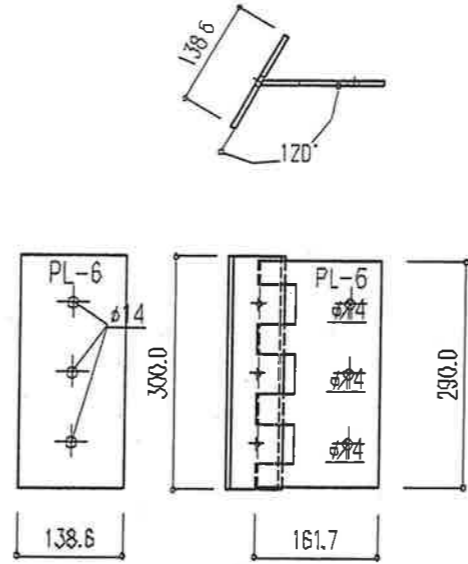

梁金物

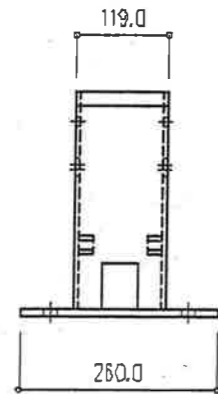
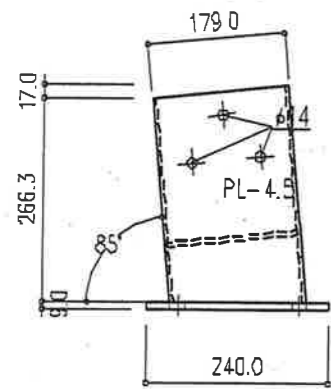

F3-9 ベース金物 4台

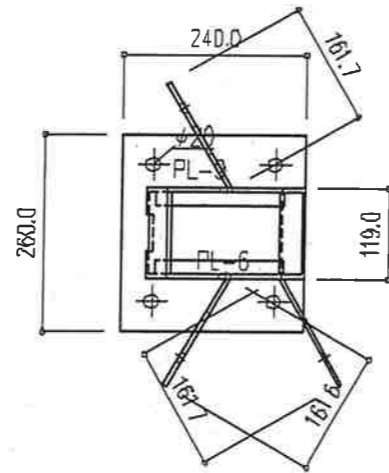

ベース金物

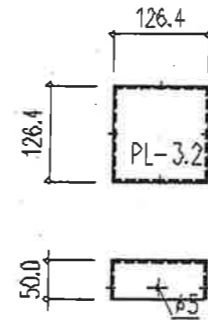

支柱キャップ

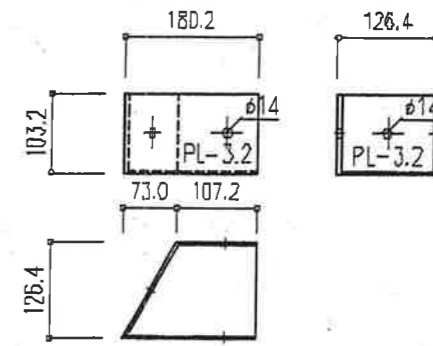

F3-17 手すり受金物 4台

鋼材 SS400  
防錆処理方法 溶融亜鉛メッキ仕上

名称 四日市別山ニラダの3号公園ファミリー3工事